

bemodern

FIREPLACES & STOVES | BATHROOM FURNITURE

Model 2917

Vue Electric Freestanding Stove



Complete with Remote Control

Instructions for use

**This product is only suitable for well insulated spaces or
occasional use**

Contents

Tech Specs	3
Safety Info	4 – 5
Stove Options	6 - 7
User Instructions	8 – 12
Re-setting thermal cut out	13
Maintenance	14
General information	15
Guarantee	16

Technical Specification

Model No.: 2917

Supply Voltage: AC 230-240V 50Hz

Maximum power consumption: 1.8KW

Power for flame effect: 14W (LED 12W + Motor for flame 2W)

Weight 30Kg

Dimensions:

Complete - H 1035 x W 450 x D 404 (mm)

Option 1 No feet – H 931 x W 450 x D 404 (mm)

Option 2 No log store – H 704 x W 450 x D 404 (mm)

Supply Voltage and Rating Power: 240 V AC , 50Hz 1800W

Fuse Rating: 13 Amp

Heating Element: 1800W

Lighting: LED

Heat Output:

Nominal heat output (Pnom): 1.8KW

Minimum heat output (indicative) (Pmin): 0.9KW

Maximum continuous heat output (Pmax): 1.8KW

Auxiliary Electricity Consumption:

At nominal heat output (elmax): N / A

At minimum heat output (elmin): N / A

In standby mode (elSB): 0kW

Type of heat output / room temperature control

Single stage heat output and no room temperature control	No
Two or more manual stages, no room temperature control	No
With mechanic thermostat room temperature control	No
With electronic room temperature control	No
Electronic room temperature control plus day timer	No
Electronic room temperature control plus week timer	Yes

Other Control Options

Room temperature control, with presence detection	No
Room temperature control, with open window detection	No
With distance control option	No
With adaptive start control	No
With working time limitation	No
With black bulb sensor	No

Safety Information

Read all of the instructions carefully before using the appliance.

For indoor use only This appliance is not suitable for use outside the house and **only suitable for well insulated spaces or occasional use.**

Do not use this appliance in the immediate surroundings of a bath, a shower or a swimming pool or any wet area

This fire must not be located immediately below or above a socket-outlet.

This appliance must be earthed.

This appliance must not be supplied through an external switching device, such as a timer, or connected to the circuit that is regularly switched on and off by utility in order to avoid a hazard due to the inadvertent resetting of the thermal cut out.

A non-rewirable plug fitted with a 13A fuse is supplied. Should the fuse or plug need replacing, and you are competent to do so, it must be replaced with a 13A fuse or plug being 13A BS1363A approved.

If the power cord is damaged, it must be repaired by the manufacturer, its authorised service centre or professional person.

The meaning of this symbol  is "DO NOT COVER". **Warning:** in order to avoid overheating, do not allow the appliance to be covered or let the air inlet / outlet to become obstructed. Please note the warning symbol on the appliance (see above).

To reduce the risk of fire, keep textiles, curtains, or any other flammable material a minimum distance of 1 meter from the air outlet.

Keep the power cord away from hot surfaces and hot conditions. Do not route the power lead in front of the appliance.

Do not use this fire in rooms that have explosive gas in them (for example petrol), or if you are using solvents, glue, aerosol spray or in flammable paints, as these may catch fire.

Safety Information *(continued)*

Children and vulnerable people must be supervised at all times when using this appliance, as some parts can become very hot and cause burns.

This appliance shall not be played with by children.

Children of less than 3 years should be kept away unless continuously supervised.

Children aged from 3 years and less than 8 years only can switch on / off the appliance provided that it has been placed or installed in its intended normal operating position and instructions and supervisions concerning the safe way of the use of the appliance are offered. Children aged from 3 years and less than 8 years shall not plug in, regulate and clean the appliance or perform user maintenance.

This appliance can be used by children aged from 8 years and above and persons with reduced physical, sensory or mental capabilities or lack of experience and knowledge if they have been given supervision or instruction concerning use of the appliance in a safe way and understand the hazards involved.

Do not use this appliance in small rooms when they are occupied by persons not capable of leaving the room on their own, unless constant supervision is provided.

Cleaning and user maintenance shall not be made by children without supervision.

Stove Options

This model has been designed to be free standing and is normally positioned against a wall.

The stove comes complete with the log store and feet, however this can be changed to one of the following variants.

Note: This product is a two adult person lift. A second person will be required to support / lift the product into position or removal of the feet or log store.

Option 1 - Stove and log store only (no feet).

Remove the four screws securing the feet to the log store then carefully lift the unit up so the feet can be removed.

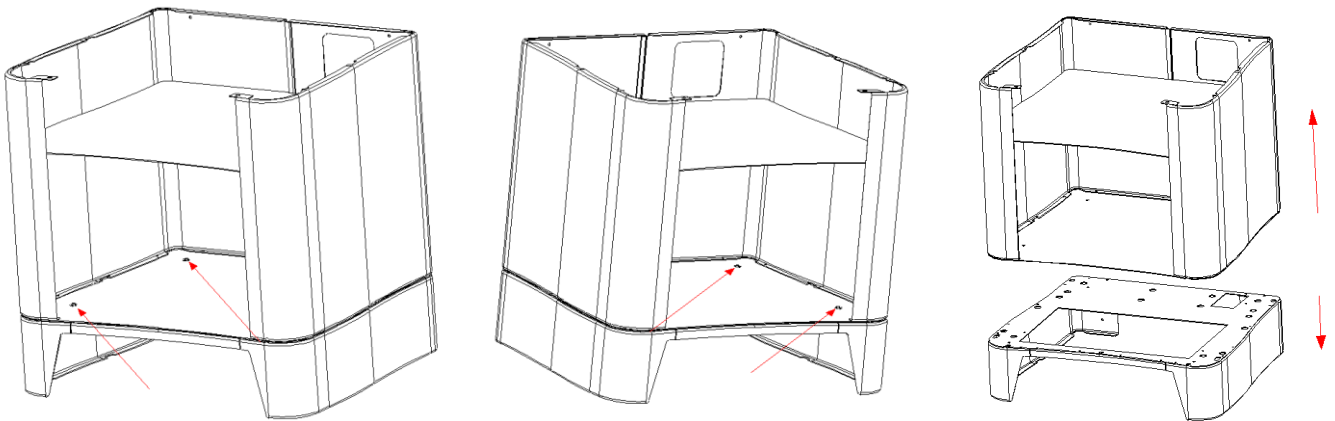

Option 2 – Stove and feet only (no log store).

The stove unit needs to be removed from the log store and feet, this is done by removing the two screws from the under side front of the unit and two from the rear. Once the screws have been removed lift the stove engine off the log store.

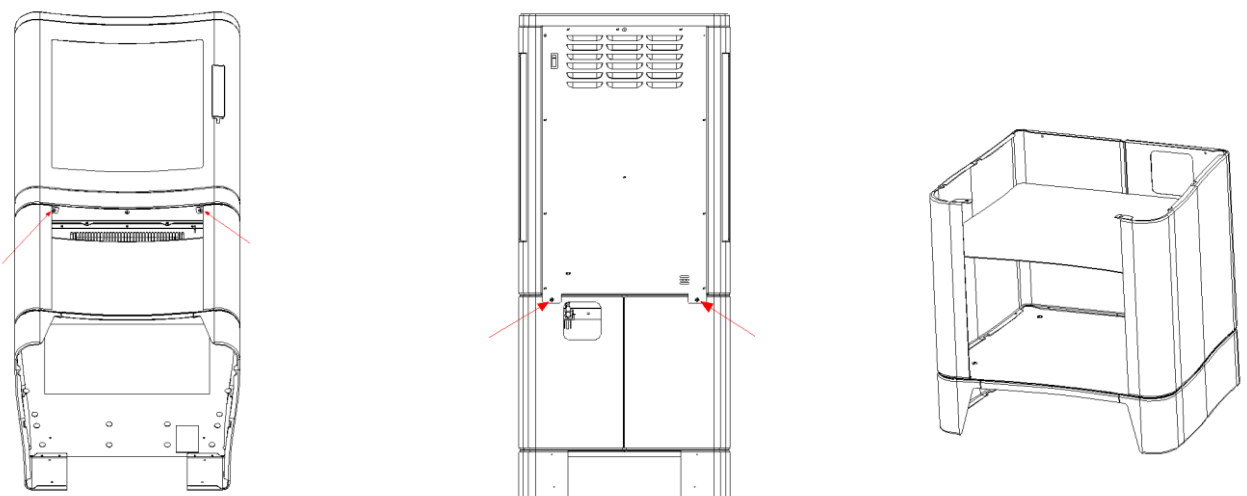

Stove Options continued

Remove the four screws from the base of the log store and lift log store off the legs

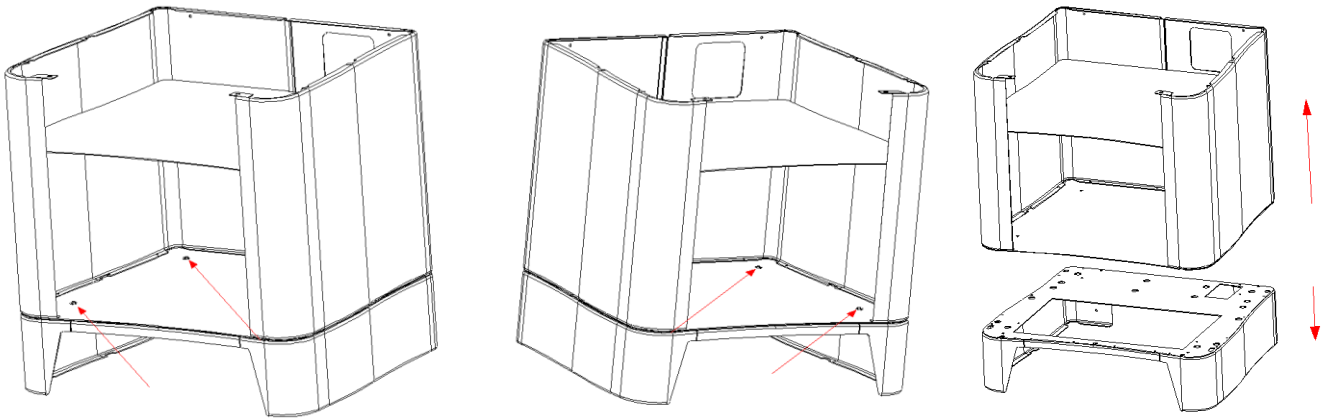

Feed the mains cable through the cut out in the legs then place the stove engine onto the legs and secure via the two screws on the under side of the feet and two on the rear on the stove engine.

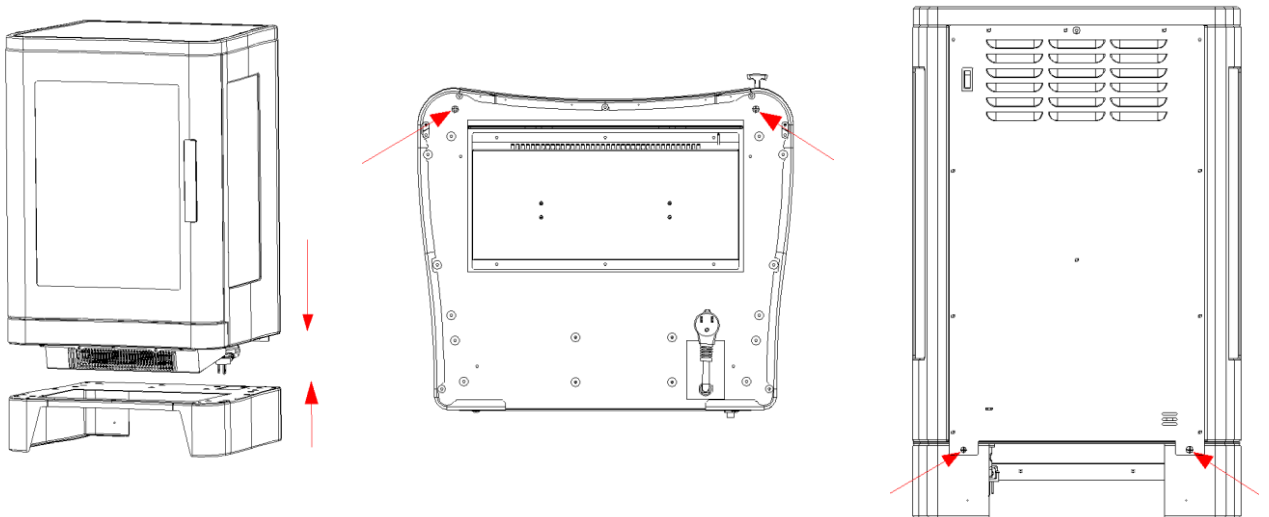

User Instructions

This model has been designed to be free standing and is normally positioned against a wall.

WARNING! Do not operate the appliance if it is damaged or has malfunctioned. If you suspect the appliance is damaged or has malfunctioned call a qualified service engineer to inspect the appliance, and replace any part of the electrical system if necessary, before reuse.

WARNING! To reduce the risk of fire, keep textiles, curtains, or any other flammable material a minimum distance of 1 meter from the air outlet.

MAKE SURE the plug fits tight in the outlet. Faulty wall outlet connections or loose plugs can cause the outlet to overheat.



Do not disconnect the power at the mains supply whilst the appliance is running. Ensure the mains switch has been moved to the off position before disconnecting.

Main Power Switch

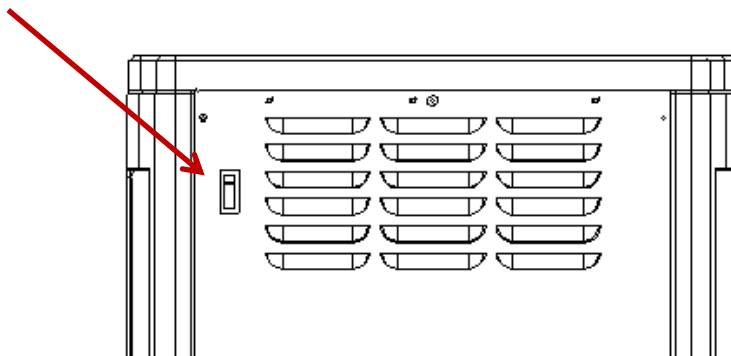
The main power switch is located on the rear of the appliance. This needs to be switched ON before operating the manual / remote controls.



Pairing the handset

Within 1 minute of turning the power on by the main power switch press and hold  and the  buttons on the remote control for 3 seconds to remotely pair the handset to the appliance, the LCD will display bL and flash 5 seconds, then return to the normal display state. The remote is now paired to the appliance.

User Instructions *Continued*

Remote control

The button configuration of the remote control is shown below, information such as the flame effect, fuel bed, setting, temperature and time are displayed on the LCD screen on the remote control.

The appliance incorporates a flame effect, which can be used with or without the heating so the comforting effect can be enjoyed at any time of the year.

1. Standby button

Turns the appliance ON / OFF.

The default settings are: Heater set to "82°F / 27°C", the main flame effect is F1, and the Fuel bed is L1.

2. Flame effect button

Changes the flame effect brightness : F1, F2, F3, F4,

3. Heater button

Heater button, switches to the temperature adjustment option where the weekly timing function can be adjusted. Use the "+" and "-" buttons to select the desired temperature.

Temperature Setting range:

Centigrade: 17°C, 18°C, 19°C, 20°C, 21°C, 22°C, 23°C, 24°C, 25°C, 26°C, 27°C, ON, 17°C (Cycle)

Fahrenheit: 62°F, 63°F, 64°F, 65°F, 66°F, 67°F, 68°F, 69°F, 70°F, 71°F, 72°F, 73°F, 74°F, 75°F, 76°F, 77°F, 78°F, 79°F, 80°F, 81°F, 82°F, ON, 62°F (Cycle)

*Pressing and holding the heater button for 3 seconds will change between °C to °F.

4. Fuel bed button

Changes the brightness of the fuel bed : L1, L2, L3, L4

5. Timer button

Adjusts the timer: 1H, 2H, 3H, 4H, 5H, 6H, 7H, 8H, 9H, off

6. Setting button

To enter the time and weekly timer settings.

7. "-" button

This button can be used to adjust the temperature when the heating is turned on. -1°C when you press this button.

8. "+" button

This button can be used to adjust the temperature when the heating is turned on. +1°C when you press this button.

9 . Date button

To choose from Monday to Sunday or week timer mode option. Option mode: 1-2-3-4-5-6-7-A-off

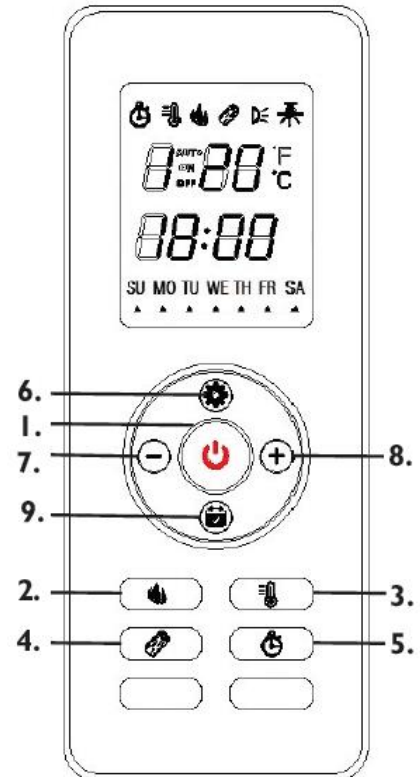

User Instructions *Continued*

Flame effect button

Press this button to adjusted the flame brightness settings F1, F2, F3 ,F4, F1.

Button	Display	Flame effect
1st press	F1	The flame effect is fully illuminated
2nd press	F2	The flame effect is medium illuminated
3rd press	F3	The flame effect is low illuminated
4th press	F4	The flame effect automatically switches from bright to dark

Heater button

Press the heater button to turn the heating function on and off and adjust the temperature setting. Temperature settings: 17°C, 18°C, 19°C, 20°C, 21°C, 22°C, 23°C, 24°C, 25°C, 26°C, 27°C, ON, 17°C.

Pressing this button in the power-on state will turn on the heating function. Press and hold this button for 3 seconds to select the temperature. The temperature display window will flash. After the temperature is set, the display unit will flash 5 times, then automatically save the settings and exit the setting display

Fan delay function

After the heater is turned off the fan will continue running for 15 seconds then stop.

Window detection function

When the appliance heating is on, if the ambient temperature suddenly drops $\geq -5^{\circ}\text{C}$ within 10 minutes, and the environment cannot be warmed up within 30 minutes.

The appliance buzzer will ring 5 times a second and the touch button indicator on the appliance flashes 5 times, and the front and rear flame effects will flash.

The heating function will be automatically turned off when this happens, it can be turned off and then restarted to clear the fault code.

Fuel bed button

Press this button to adjust the fuel bed brightness settings L1, L2, L3, L4, L1.

Button	Display	Fuel bed effect
1st press	L1	The fuel bed effect is fully illuminated
2nd press	L2	The fuel bed effect is medium illuminated
3rd press	L3	The fuel bed effect is low illuminated
4th press	L4	The fuel bed effect automatically switches from bright to dark

If both the fuel bed and flame effect are off and the heater is turned on both the fuel bed and flame effect will automatically turn on the F1 / L1 setting.

User Instructions *Continued*

Timer button



Press the "Timer" button to adjust the time, plus one hour for each press.
Timing range: 1H, 2H, 3H, 4H, 5H, 6H, 7H, 8H, 9H, OF, 1H (cycle adjustment).

Clock and week timer settings

Date button  Use the date button to choose from Monday to Sunday or week timer mode option. Option mode:1-2-3-4-5-6-7-Auto-off

Clock setting :

When in standby (after the unit is plugged in and before pressing "main power"), press and hold the Setting button  on the remote for 3 seconds, the digital display will flash "00:00". Press "+" on the remote control to set the hour, press the remote control "-" to set the minute.



Press "Setting" to enter the setting of the week timer. Press "" to select Sunday to Saturday. The date symbol will light up after the day is selected. When finished, press the "Setting"  button to exit setting.

The current  clock must be set after the initial power-on or power-off, otherwise the clock will remain "00:00" status and you won't be able to set the week timer function. The time symbol will light up automatically after the batteries have been installed. The backlight will automatically turn off after 5 seconds of no button operation.





Heat setting :

Use remote control's Heater button  to select the temperature, the system default parameters: heater 82°F/ 27°C. Press "+" / "-" buttons to select the temperature when the heating is turned on. Temperature range: 17°C, 18°C, 19°C, 20°C, 21°C, 22°C, 23°C, 24°C, 25°C, 26°C, 27°C, ON, 17°C.



While the remote is in standby, press the setting button  on the remote for 3 seconds to enter the preset timing on / off of the week timer. Enter mode 1, while the display is 1 ON, the clock will show "01:00", press "+" to set hour, press "-" to set minute, press  to set the week, every press on the  will display SU, MO, TU, WE, TH, FR, SA and flash in turn, you can use the "+" key to select the desired date and use the "-" key to remove the desired date, Δ shows all of the days selected.





Press the "Heater"  button to enter temperature setting, then press "+" / "-" button to set temperature. Press "Setting"  again to set the timing to off, the display is 1 OFF, the clock is displayed as "02:00", press "+" to set hour, press "-" to set minute. The date of the timer off is the same as the timer on, you can't change this manually. After setting, press the "Setting"  button to enter setting of mode 2, the operation is the same as mode 1. You can set mode 1 to mode 7 with the above method. If you don't need to select other mode setting, press  or  on the remote for 3 seconds to save setting and exit week timer setting.

User Instructions *Continued*

Press the  button to select the desired timing mode 1-2-3-4-5-6-7- or auto option, your chosen option will be saved after 5 seconds if no other buttons are pressed, the timer logo on the display will illuminate and automatically run the preset program. You can individually select each setting of modes 1-7 for automatic on / off switching, or you can preset the desired settings and then select "auto mode" for multiple preset settings.

If you want to set the on / off switch and temperature setting for different periods of the week, then set the switching time and temperature of each day from Sunday to Monday in mode 1-7. After setting, use "auto mode" to run the timing switch and then system will run the week timer of 1-7 modes. You can also set 1-7 modes within 1 day, use "auto mode" to run timing switch on / off within 1 day. Be aware that when you use "auto mode", you need to make sure the settings of the times do not overlap each other, otherwise the timer will not function correctly.

After entering the week timer setting, press the  button for 3 seconds to exit week the timer mode, the timer symbol will be extinguished.

You can check the 1-7 timer settings by pressing the "Setting"  button. For example, press the "Setting" button to display (1 ON "01:00" temperature 27°C), press the "Setting" button again to display (1 OFF "02:00" temperature 27°C). Press the "Setting"  button again to display (2 On "03:00" temperature 26°C) then press the Setting button to display (7 OFF "13:00" temperature 27°C).

The remote control and the appliance must be kept within 4 meters (unshielded state) of each other at all times when being operated in the weekly timing mode.

After the weekly time is turned on, the remote controller automatically controls the appliance at the set time.

Manual control

The touch buttons for manual operation are mounted in the glass top. On / Off (A), Flame effect (B), Fuel bed (C) and Heat Function (D). The buttons for the flame effect and fuel bed operate the lighting effects the same way as the remote.

Flame effect button (B)

Press this button to adjusted the flame brightness settings F1, F2, F3 ,F4, F1.

Fuel bed button (C)

Press this button to adjust the fuel bed brightness settings L1, L2, L3, L4, L1.

Heater Button (D) Press once to operate the 0.9kW setting, press again will switch the 1.8kW heat setting.



[D]

[C]

[B]

[A]

Re-setting the Thermal Cut Out

The appliance is fitted with an Electronic Safety Control (E.S.). This is a safety device, which switches off the fire if, for any reason, the appliance overheats, e.g. if covered. If the heater stops operating while the flame effect continues working normally, this indicates that the E.S. Control is in operation. The E.S. Control can only be reset after the appliance has cooled down, and the appliance has been reset. Resetting of the E.S. Control proceeds is as follows:

Switch off the appliance (On / Off switch), unplug or switch off from wall socket and leave it off for approximately 10 -15 minutes.

Remove any obstruction to the fan heater outlet or fan blades etc. Make sure that the power supply is disconnected at the plug socket outlet while doing this.

Plug back in to the mains socket, switch on the appliance and the E.S. Control will be re-set.

When the appliance E.S. is triggered, the heater relay will trip and the heater LED will flash continuously. The Heater function will not accept any commands until the above procedure has been followed to re-set the E.S.

Ensure that the appliance is functioning correctly. If the E.S. Control operates again, the appliance should be checked by a competent electrician.

Maintenance

WARNING: Before any maintenance or whilst cleaning the exterior of the fireplace, the unit should be disconnected from the power supply until it has cooled down.

Cleaning the Fire

Cleaning or polishing products are not recommended. Fingerprints or other marks on the front glass panel can be removed by a piece of soft, damp, lint-free cloth with a good quality household glass cleaner. The front glass panel should always be completely dried with a clean, lint-free cloth or paper towel.

CAUTION: Abrasive cleaners should not be used on the glass panel. Liquids should not be sprayed directly onto any surface of the unit.

Electrical Connections - UK Plug Wiring Instruction

If the plug has to be changed because it is not suitable for your socket, or due to damage, please follow the wiring instructions shown below.

The wires in the mains lead are coloured in accordance with the following code:

BROWN	:	LIVE (L)
BLUE	:	NEUTRAL (N)
GREEN / YELLOW	:	EARTH (E)

As the colours of the wires in the mains lead of this appliance may not correspond with the coloured markings identifying the terminals in your plug, as follows

The BLUE wire is the NEUTRAL and must be connected to the terminal which is marked with the letter N or coloured BLACK.

The BROWN wire is the LIVE and must be connected to the terminal that is marked with the letter L or coloured RED.

The wire which is coloured GREEN / YELLOW must be connected to the terminal which is marked E or the earth symbol or coloured GREEN or GREEN / YELLOW.

Always ensure that the cord grip is positioned and securely fastened.

WARNING: THIS APPLIANCE MUST BE EARTHED.

If a 13A (BS1363) fused plug is used it must be fitted with a BS1362 13A fuse. If in doubt consult a qualified electrician.

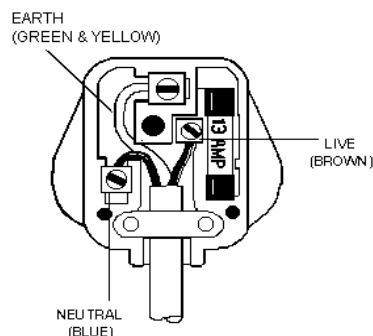

General Information

Environment



Meaning of crossed-out wheeled dustbin:

Electrical appliances should not be disposed as unsorted municipal waste. Separate collection facilities should be used in the disposal of electrical appliances. Contact your local government for the information about the available collection systems. If electrical appliances are disposed of in landfills or dumps, hazardous substances can leak into the groundwater and get into the food chain, damaging your health and well-being. When old appliances are replaced by the new ones, it is a legal obligation for the retailer to take back the old appliance for disposals at least free of charge.



This fire complies with the Safety Standards EN 60335-1 and EN 60335-2-30 which covers the essential requirements of the Low Voltage Directive 2014/35/EU and the EMC standards EN 55014-1; EN 55014-2; EN 61000-3-2 and EN 61000-3-3 which covers the essential requirements of the European Electro Magnetic Compatibility 2014/30/EU, and the RED standards EN300220-2, EN301489-1, EN301489-3 and EN6247 which covers the essential requirements of the European Radio Equipment Directive 2014/53/EU.



RoHS stands for Restriction of Hazardous Substances, and impacts the entire electronics industry and many electrical products as well. The original RoHS, also known as Directive 2002/95/EC, originated in the European Union in 2002 and restricts the use of six hazardous materials found in electrical and electronic products. All applicable products in the EU market since July 1, 2006 must pass RoHS compliance.

Electric Fire Guarantee

Be Modern Ltd. (the 'Company') provides a **twelve month** guarantee in respect of electric fire (the 'Product') ranges.

1. The twelve month Guarantee applies to:

- a. All products in the ranges manufactured by the 'Company' (but subject to the exceptions below): where:
- b. The product has been purchased and installed within the UK and in respect of
- c. The initial installation: and in favor of
- d. The original purchaser

2. Proof of Purchase must be retained by the Purchaser

3. The twelve month Guarantee does not apply to:

- a. Damage or inferior workmanship practices whilst the 'Product' is being installed
- b. Damage caused by mis-use of the 'Product' or where normal standards of care and use have not been complied with.
- c. Damage through a malfunction or an inadequately installed electric fire.
- d. Damage or defects due to mis-use, accident or unauthorised alterations.

4. During the twelve month after the "Product" has been supplied, the Guarantee covers the making good (whether by repair or replacement at the Company's option) of defects arising from defective manufacture of materials of "Product" covered in Para 1 all at no cost to the purchaser on the provision:

- a. The Product has been installed as per Be Modern recommendations. The Purchaser uninstalls the Product and makes it available for collection by Be Modern.

This Guarantee does not affect your statutory rights

On requiring service the purchaser should contact the retailer who supplied your product who will assist and advise you as necessary.

Be Modern Ltd.
19/34 Bedesway
Bede Industrial Estate
Jarrow
Tyne and Wear
NE32 3BE
Tel: (0191) 430 0901
Fax: (0191) 430 9522
<http://www.bemodern.com>